

Pogled s mora u zaljev

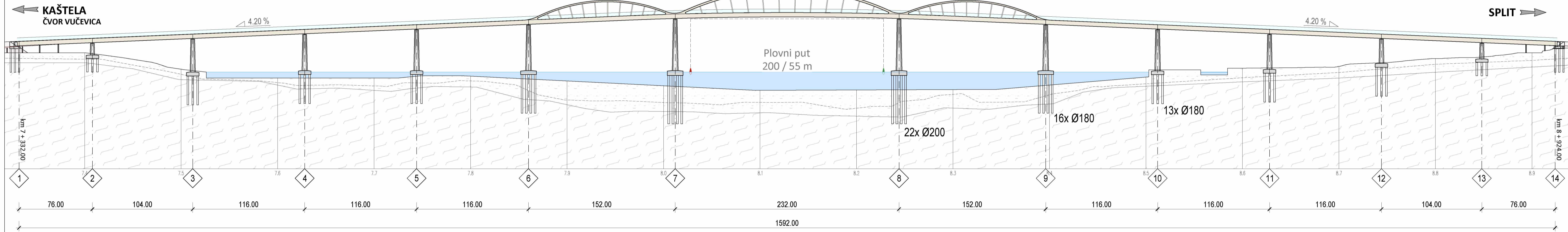

UZDUŽNI PRESJEK MOSTA
m 1:2000



TLOCRT MOSTA
m 1:2000

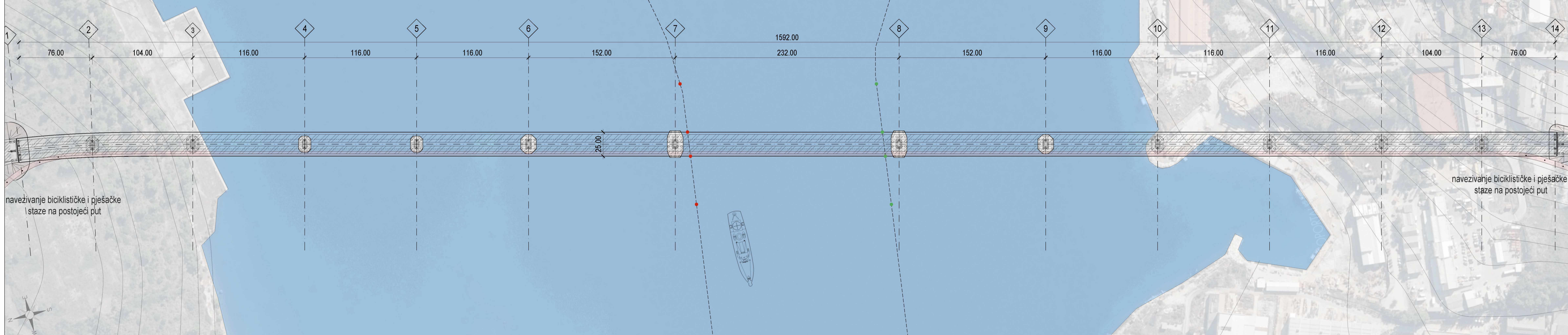

STVAL

Koncept mosta
uzdužni presjek, tloris i fasada

1 2 3 4 5 6 7

POPREČNI PRESJEK - glavni raspon
m 1:200

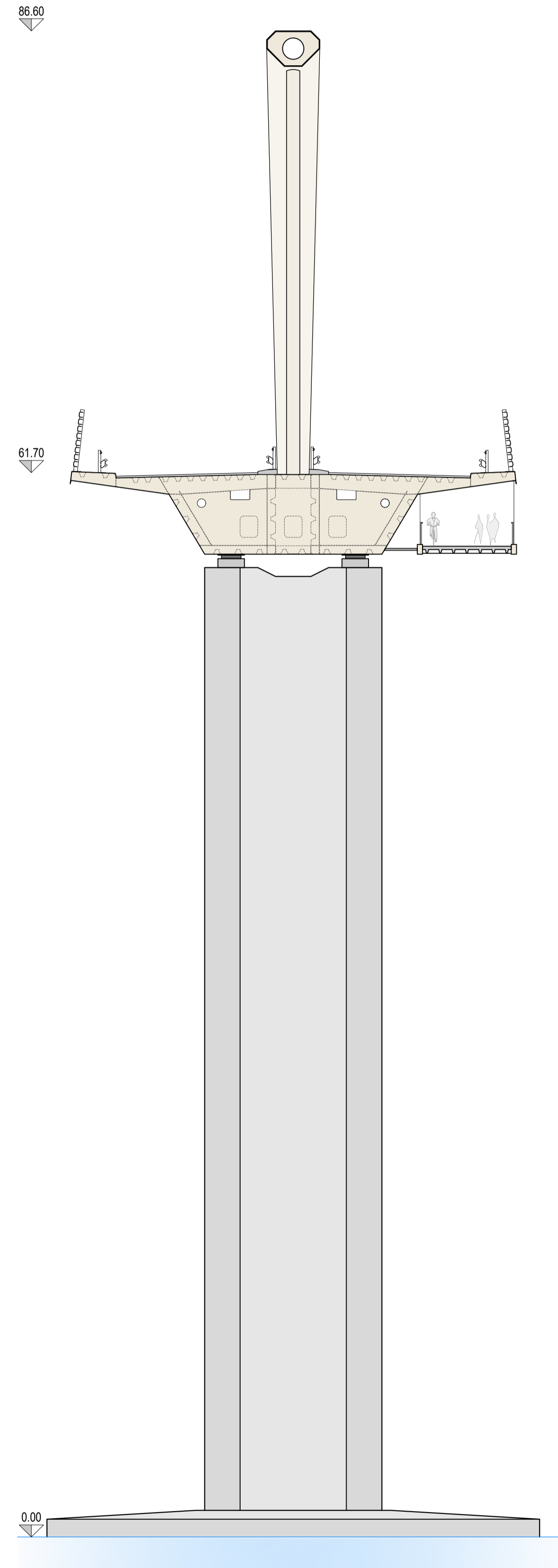

Pogled prema Splitu



Biciklisti i pješaci



POPREČNI PRESJEK - podčije grede
m 1:50

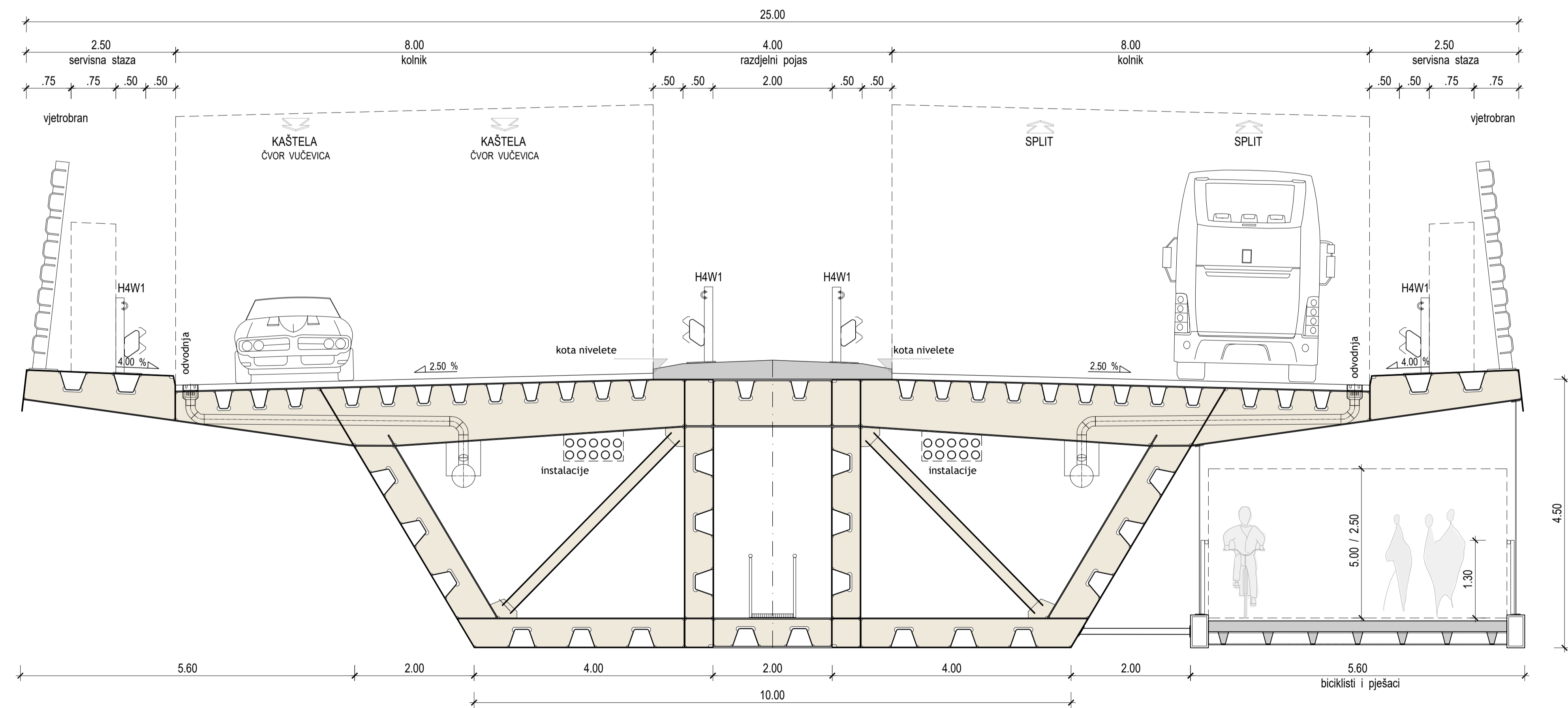

NACRT STUPOVA - glavni raspon
 uzdužni, poprečni presjek i pogled
 m 1:200

NACRT STUPOVA - podlje grede
 uzdužni i poprečni presjek
 m 1:200

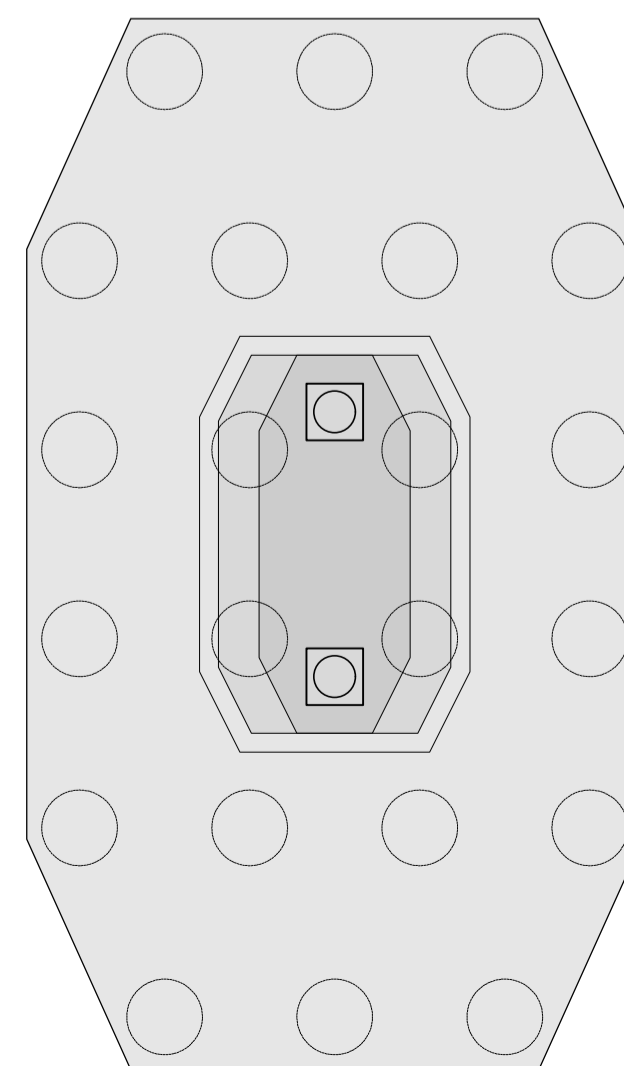
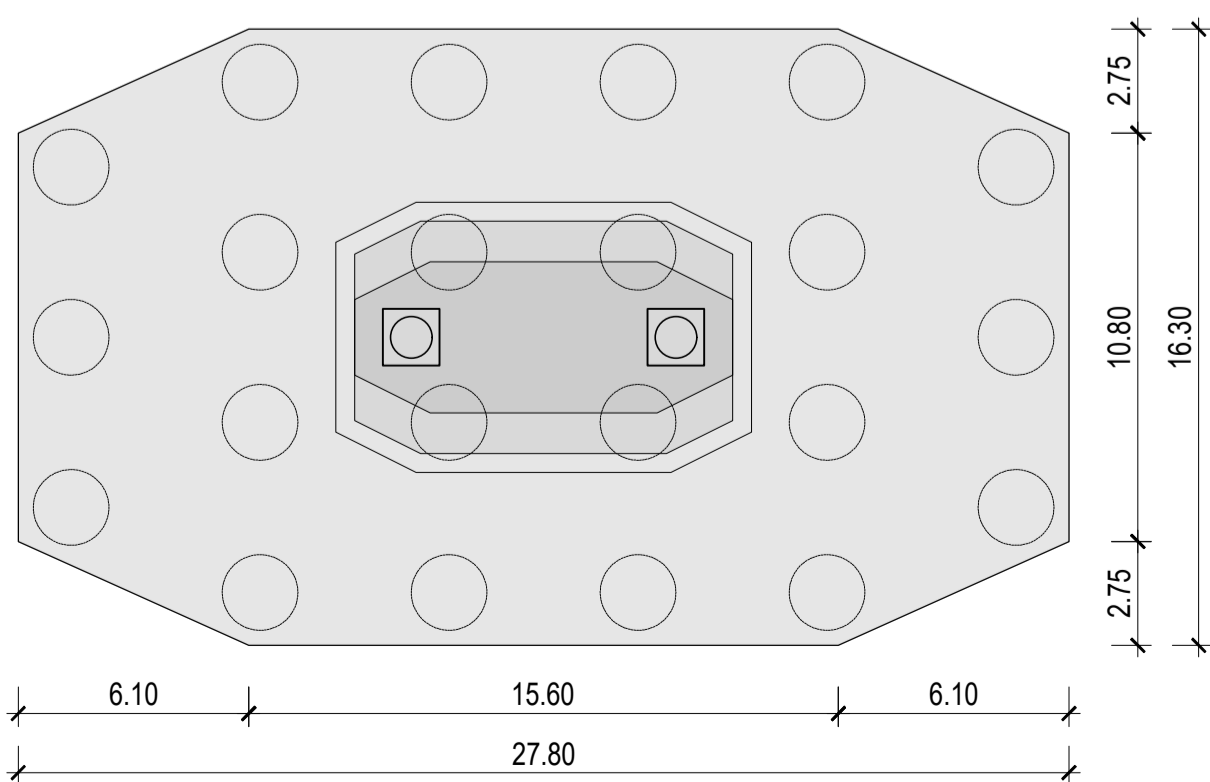
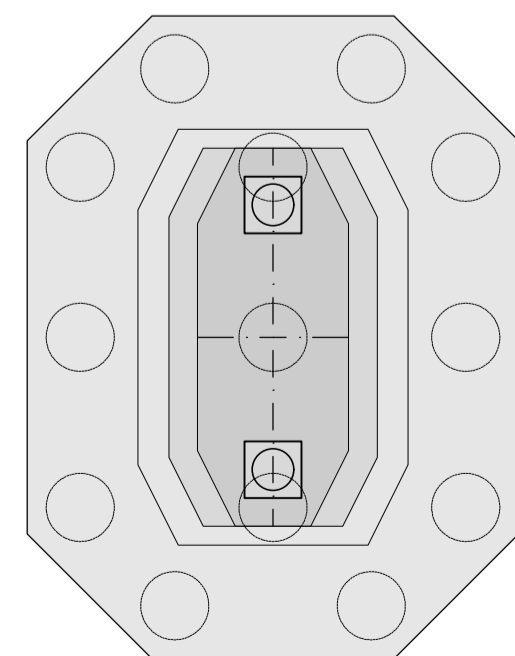
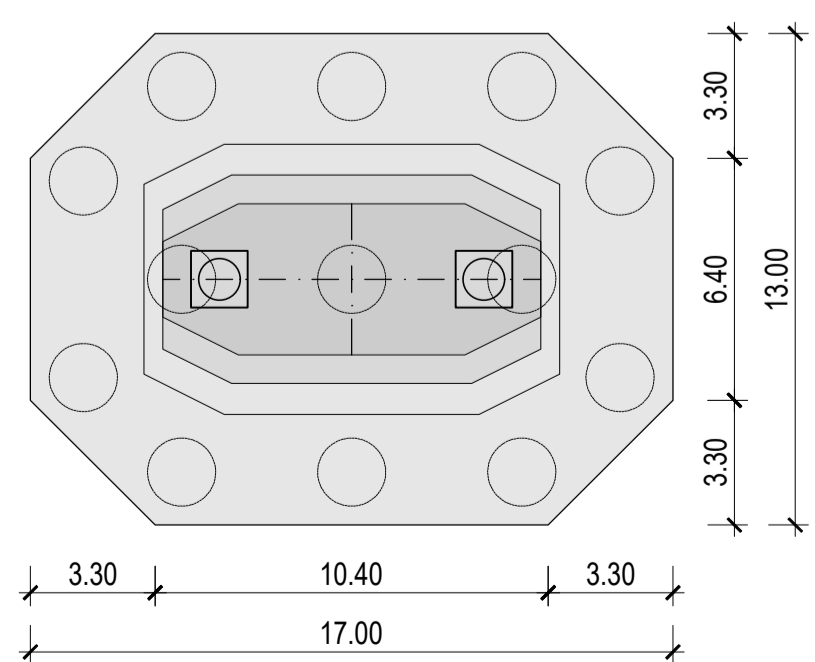
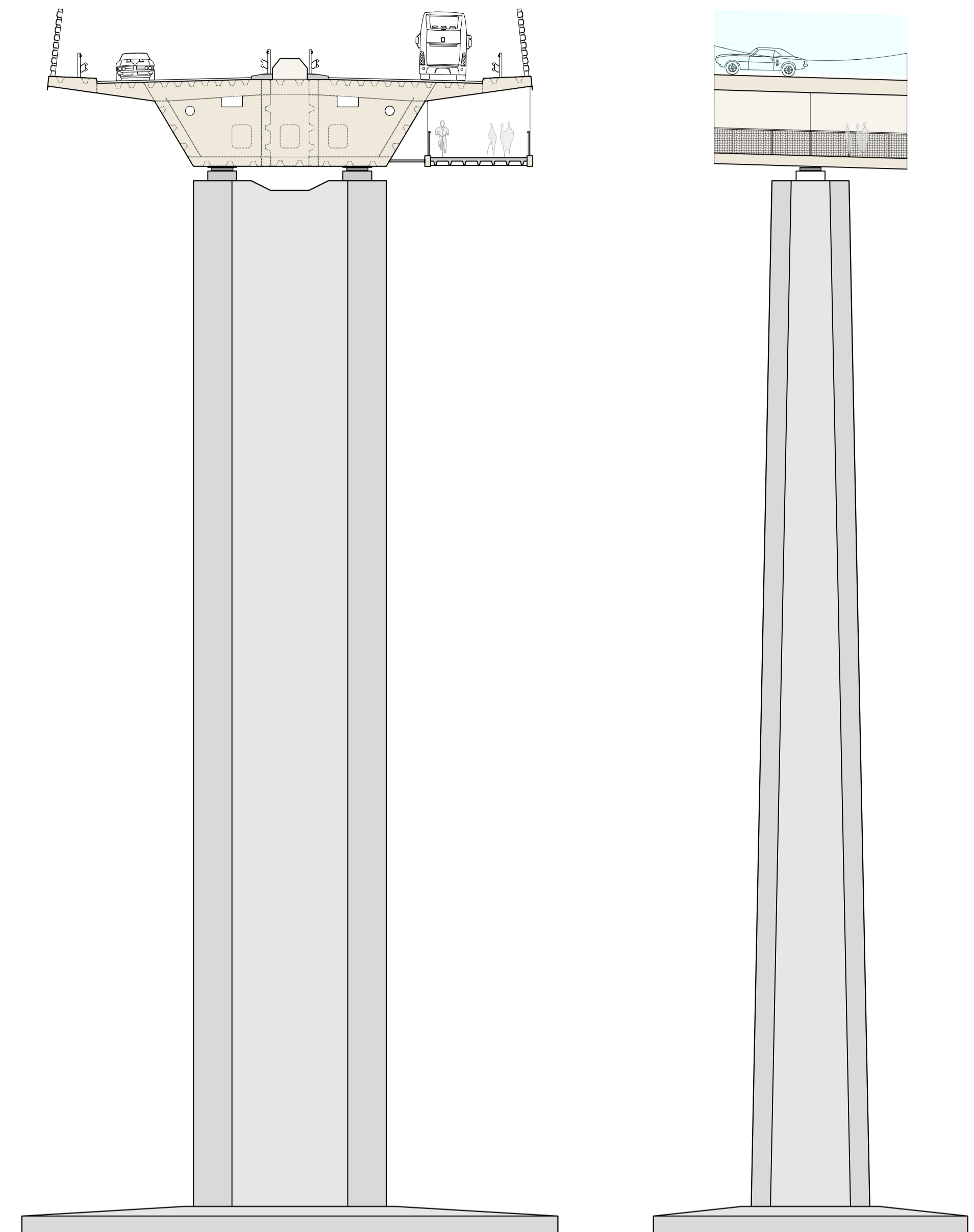
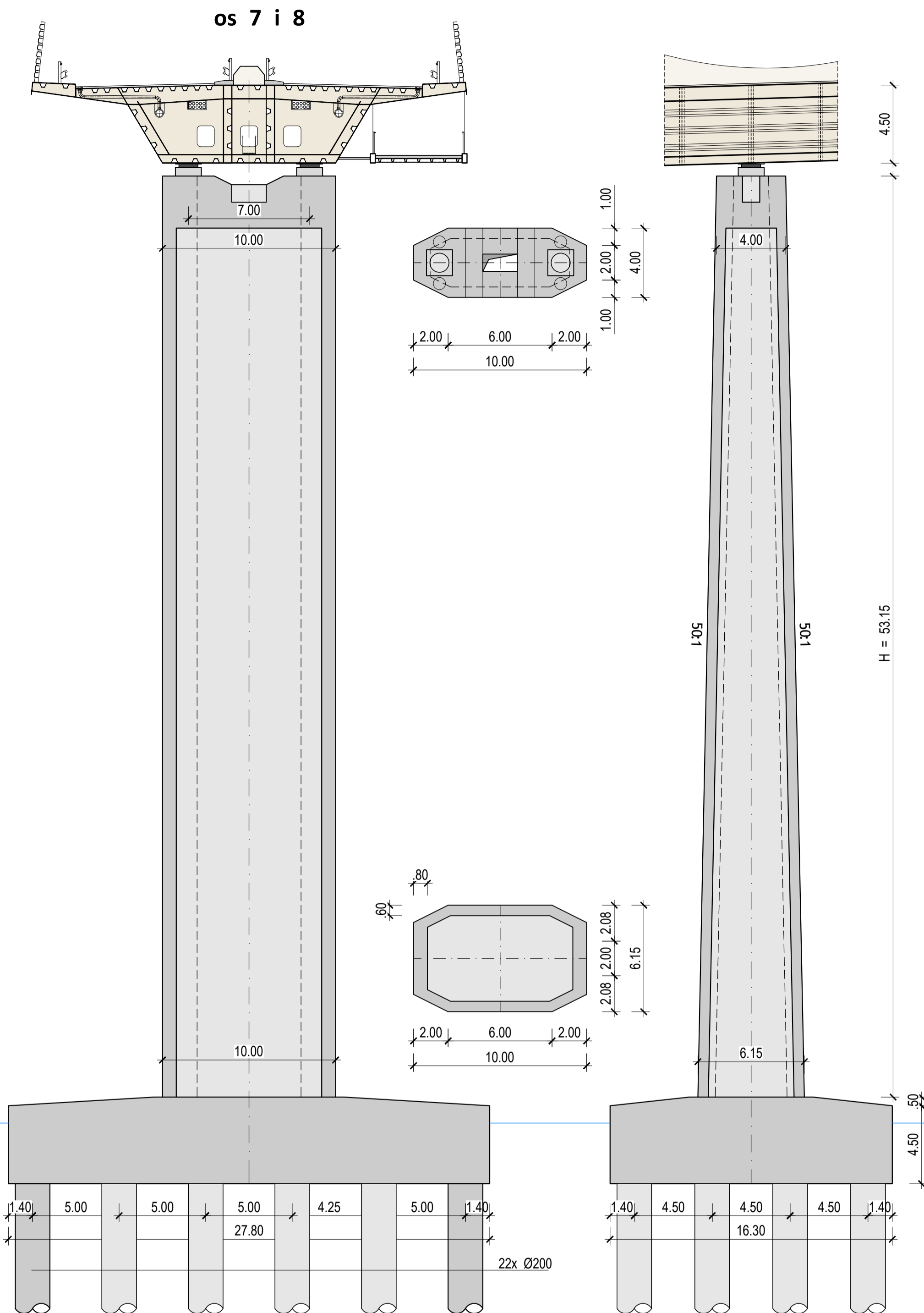
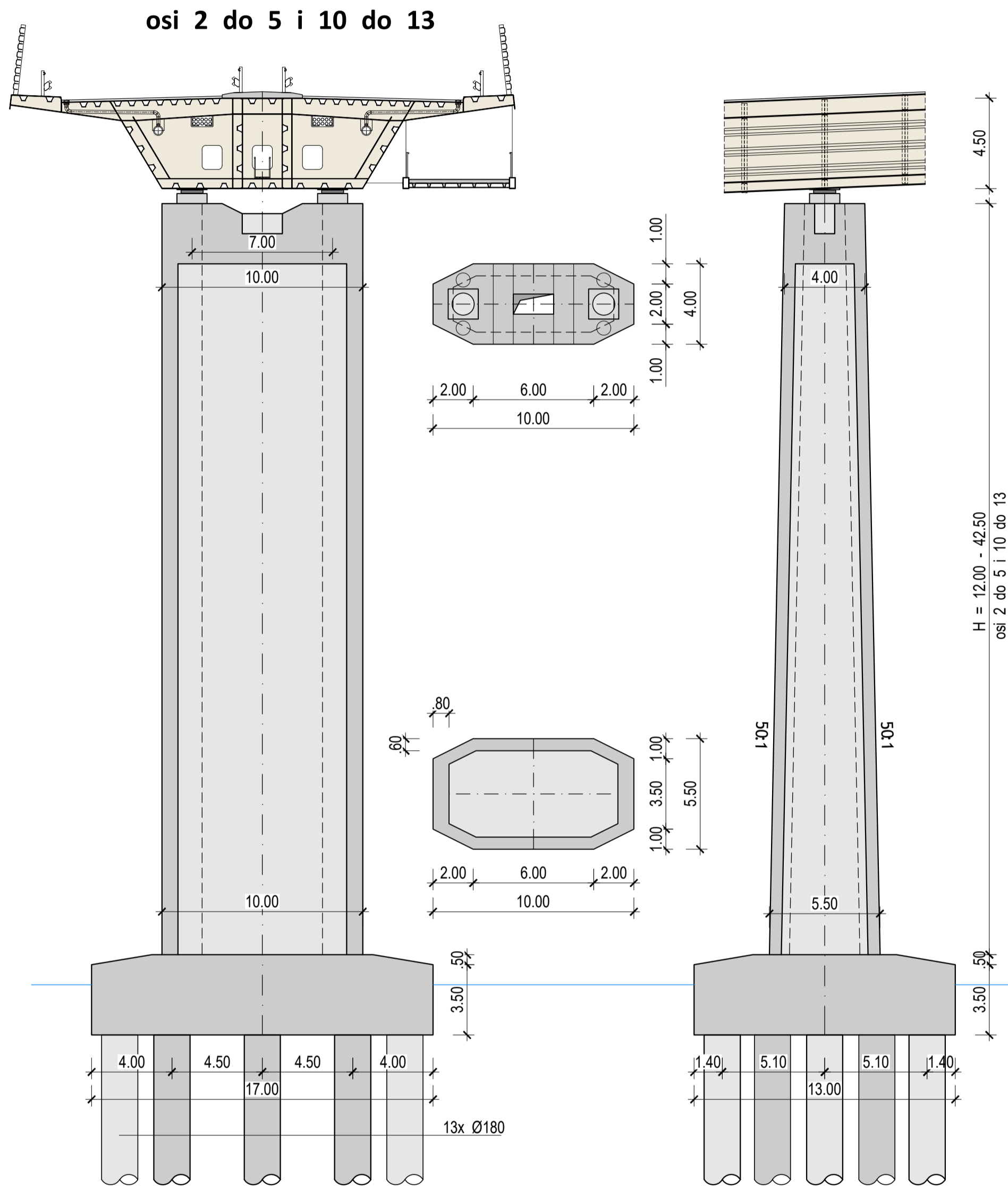

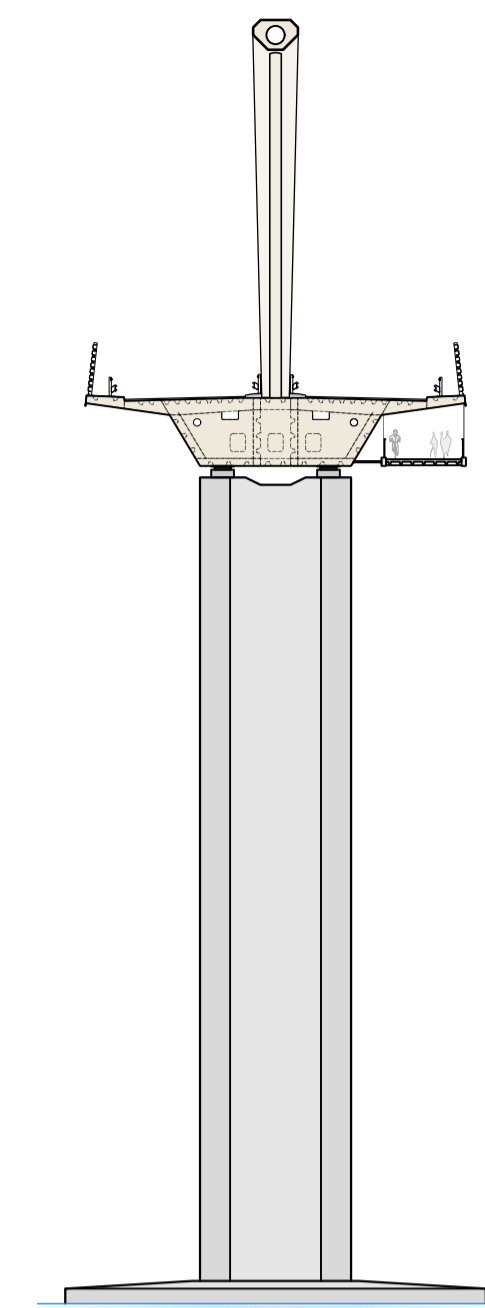
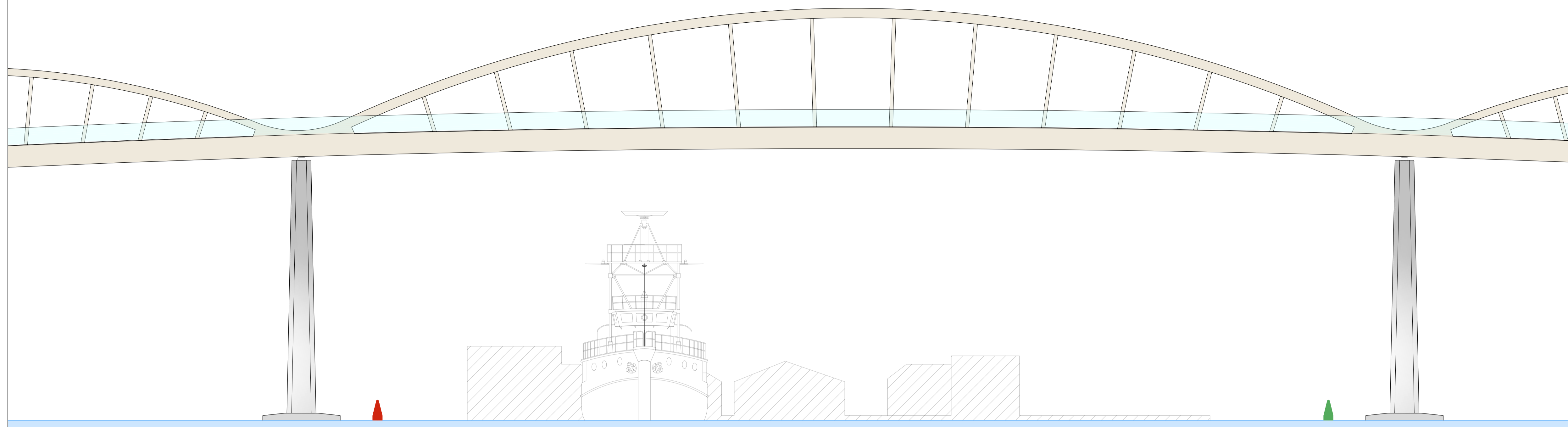

Opterećenje od prometa



Plovni put



Pogled prema Kaštela



POPREČNI PRESJEK - detalji
m 1:50

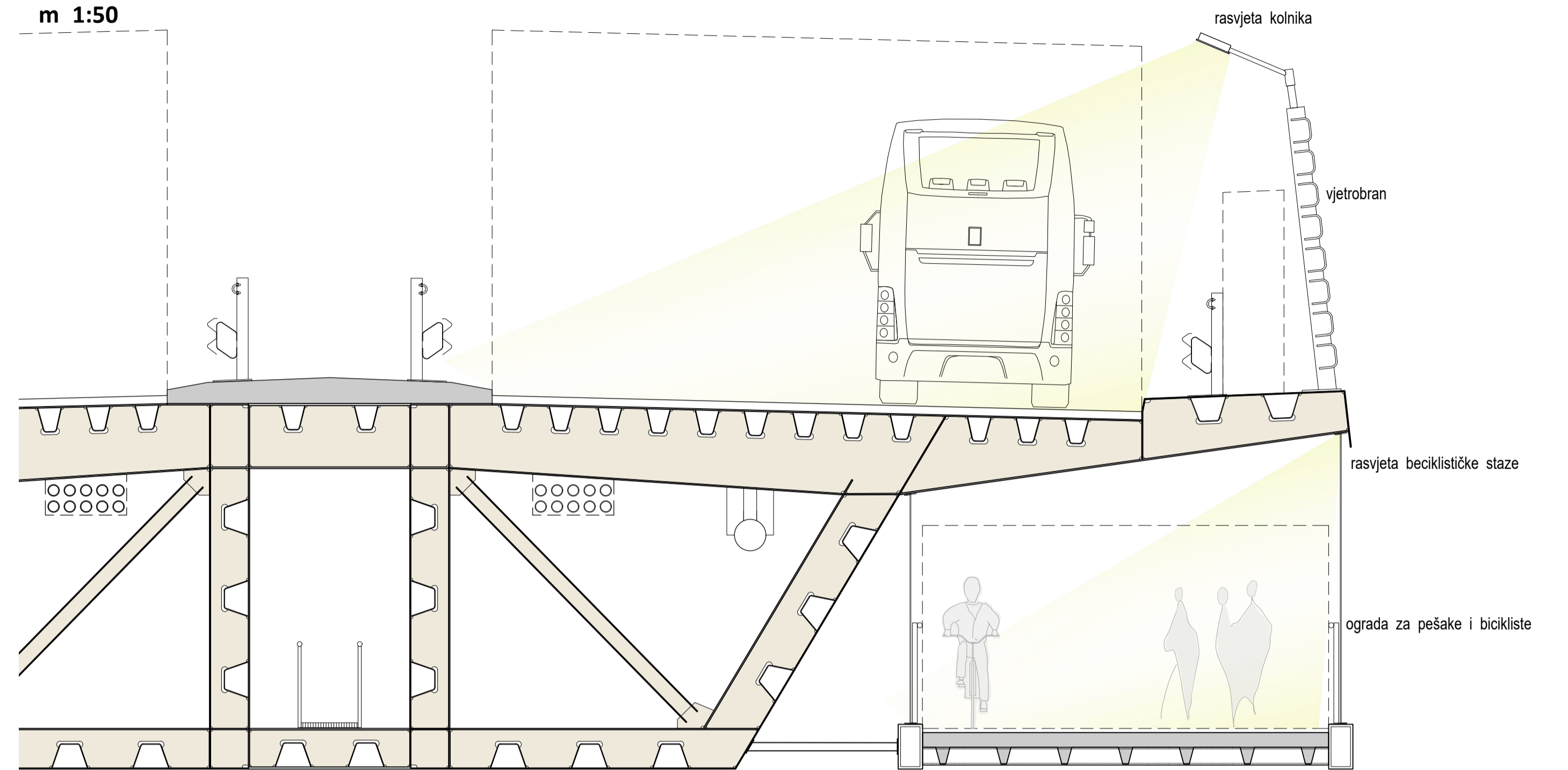

Pogled iz zaljeva



Pogled sjeverozapad

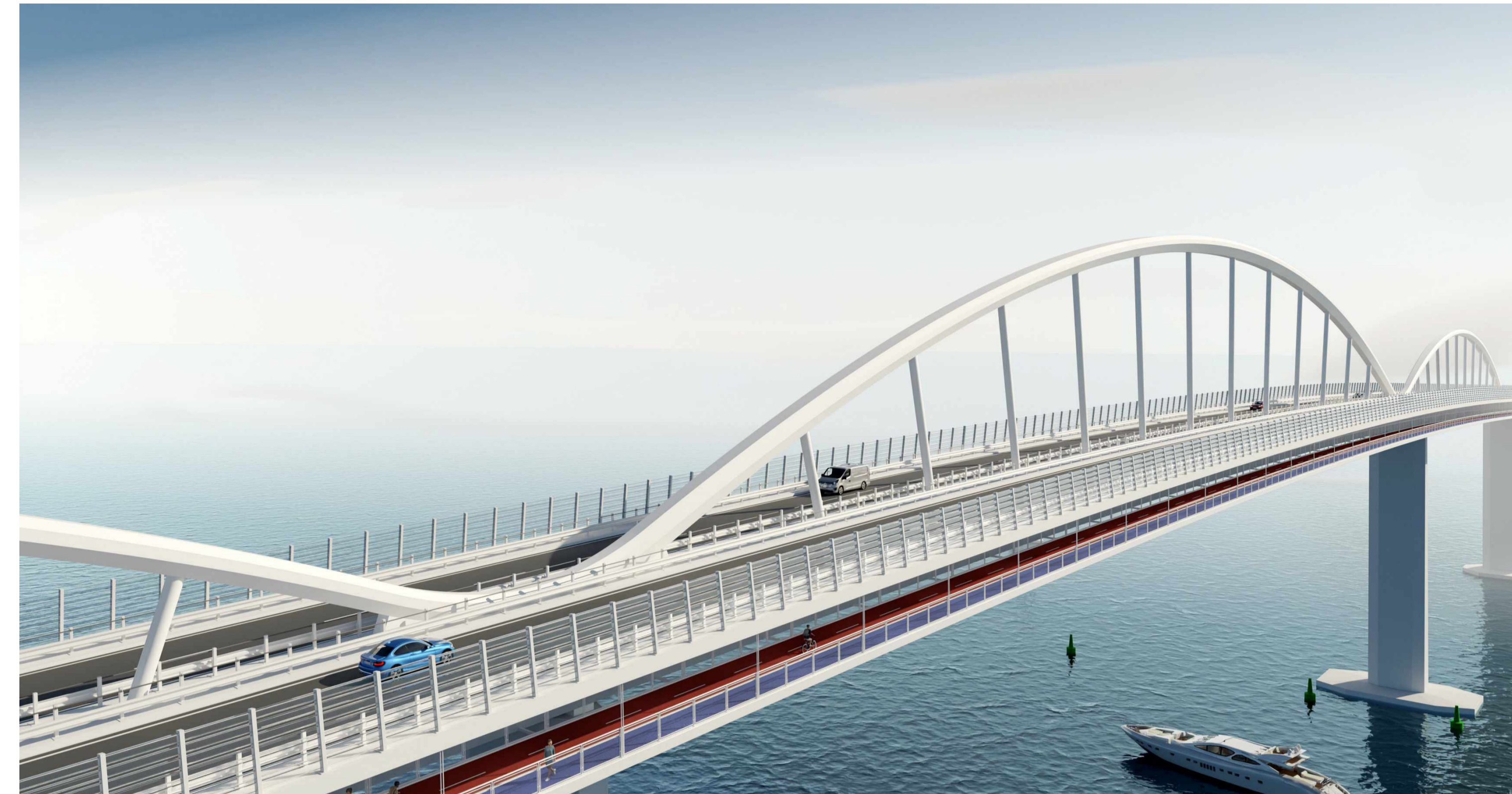

Pogled sa rasvjetom



Pristup biciklista i pješaka na most



STVAL

HEMA GRĐENJA
m 1:2000

1592.00

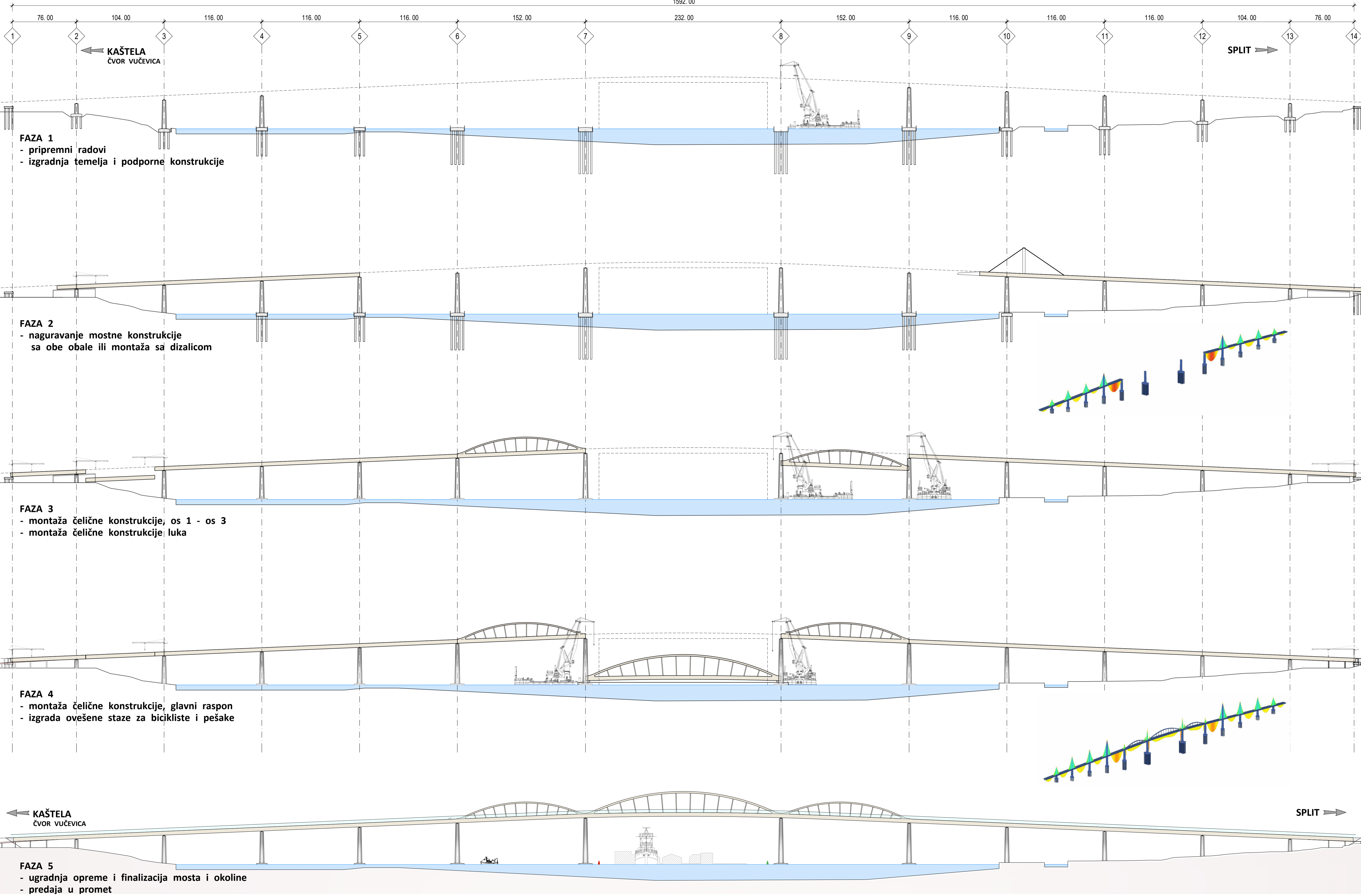

FAZA 1
- pripremni radovi
- izgradnja temelja i podporne konstrukcije

FAZA 2
- naguravanje mostne konstrukcije
sa obe obale ili montaža sa dizalicom

FAZA 3
- montaža čelične konstrukcije, os 1 - os 3
- montaža čelične konstrukcije luka

FAZA 4
- montaža čelične konstrukcije, glavni raspon
- izgrada ovešene staze za bicikliste i pešake

FAZA 5
- ugradnja opreme i finalizacija mosta i okoline
- predaja u promet